

**Distributed By  
JustCatering.Com Ltd**

10 Jessop Avenue, Norwood Green, Middlesex, UB2 5UY, UK

Tel/Fax: +44 (0)2088431712 Mobile: 07929291670

E-mail: [sales@justcatering.com](mailto:sales@justcatering.com) Web: <http://www.justcatering.com>

**CB 184**



**CB Series**



Brema

CB184A



**CB 184**



**CB 184**



**CB 184**

**Produttori automatici di ghiaccio in cubetti - sistema a spruzzo.**

Cubetti di qualità: compatti, freddi e cristallini. Per le sue ridotte dimensioni e la sua estetica può essere inserito in ogni arredamento.

**Automatic ice cube maker - spray system.**

Quality cubes: compact, cold and crystalline. For its small size and pleasant appearance it fits any furnishings.

**Machines à glaçons - système à projection d'eau.**

Cubes de qualité: compacts et cristallins. Grâce à ses dimensions réduites et à son esthétique il peut être inséré dans n'importe quel meuble.



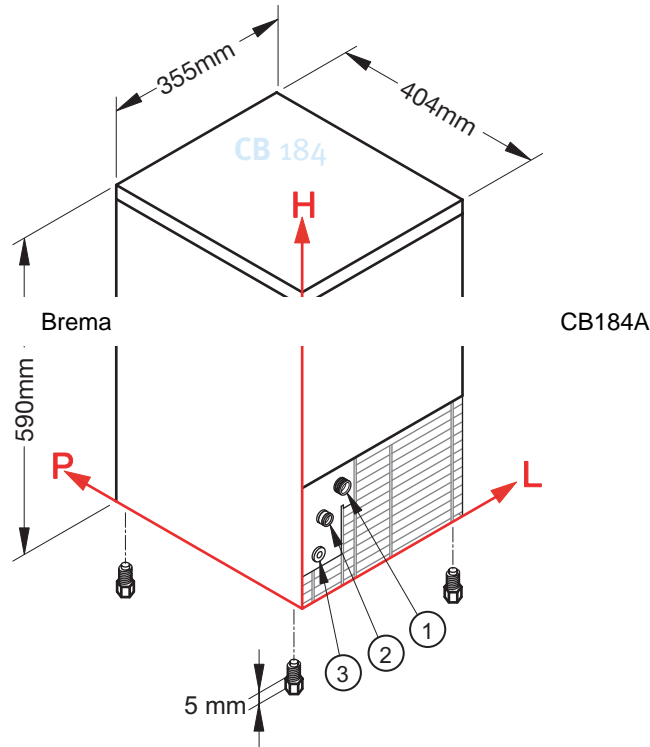

	1			2			3		
	L	H	Ø	L	H	Ø	L	H	Ø
<b>CB 184</b>	88	184	3/4"	45	138	24mm	41	73	-

	Produzione in 24 h, sino a: Production in 24 h till: Production en 24 h jusqu'à:	Capacità contenitore Storage capacity Reserve	Raffreddamento Cooling System Condenseur	Tipo di cubetto Kind of cube Type de glaçon	Refrigerante Refrigerant Fluide réfrigérant	Voltage Standard Standard Voltage Tension standard	Potenza assorbita Input power Puissance absorbée	Consumo acqua (l/kg) Water consumption (l/kg) Consommation d'eau (l/kg)	Dimensioni (LxPxH) Sizes (WxDxH) Dimension (LXPXH)	Dimensioni con imballo (LxPxH) Sizes with packing (WxDxH) Dimension (avec emballage) (LXPXH)	Peso netto/lordo Weight net/gross Poids net/brut
<b>CB 184</b>						V/Hz	W				
	21 Kg	4 kg circa 310	A W	D - 13g	R404A	220-240/1/50	320 W	A 4,5 W 20	mm 355x404x590	mm 400x470x705	28/31 Kg
Finitura - Finishing - Carrosserie				acciaio inox 18/8 18/8 stainless steel inox 18/8							



UNI EN ISO 9001  
Cert. N. 9130.BRE2



Condizioni  
Conditions  
Conditions

+21°C  
 +15°C  
 13 g  
Watt + 43°C (230/1/50)

			V / Hz	
Minimum	+10 °C	+3 °C	-10%	1bar (14psi)
Maximum	+43 °C	+32 °C	+10%	6bar (84psi)

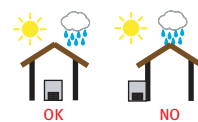

www.bremaice.it  
info@bremaice.it

CB 246 / CB 249



CB Series

Brema

CB246A



CB 246



CB 249



**Produttori automatici di ghiaccio in cubetti - sistema a spruzzo.**

Cubetti di qualità: compatti, freddi e cristallini.  
Il ghiaccio prodotto cade nel contenitore di raccolta pronto a soddisfare le esigenze di ghiaccio nelle ore di maggiore richiesta.

**Automatic ice cube maker - spray system.**

Quality cubes: compact, cold and crystalline.  
The ice produced drops into the collection bin and is ready to meet the ice requirements even at peak demand times.

**Machines à glaçons - système à projection d'eau.**



Cubes de qualité: compacts et cristallins.  
Les glaçons produits tombent dans la réserve prêts à satisfaire les exigences aux heures de pointe.





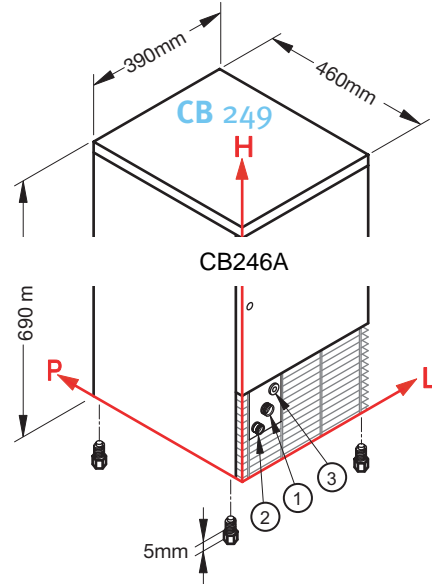
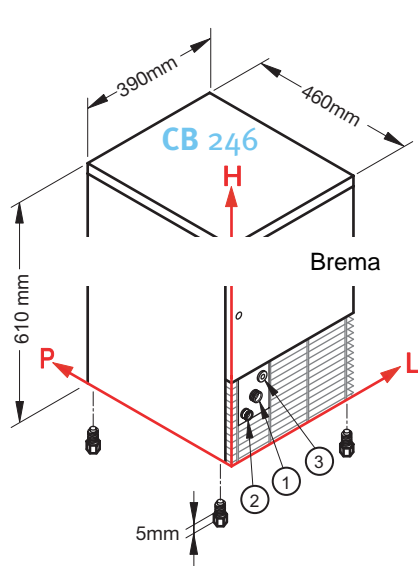



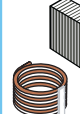

# CB Series

# CB 246 / CB 249

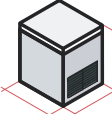

	1 			2 			3 		
	L	H	Ø	L	H	Ø	L	H	Ø
<b>CB 246</b>	111	175	3/4"	49	130	24mm	156	211	-
<b>CB 249</b>	111	175	3/4"	49	130	24mm	156	211	-

	Produzione in 24 h, sino a: Production in 24 h till: Production en 24 h jusqu'à:	Capacità contenitore Storage capacity Reserve	Raffreddamento Cooling System Condenseur	Tipo di cubetto Kind of cube Type de glaçon	Refrigerante Refrigerant Fluide réfrigérant	Voltaggio Standard Standard Voltage Tension standard	Potenza assorbita Input power Puissance absorbée	Consumo acqua (l/kg) Water consumption (l/kg) Consommation d'eau (l/kg)	Dimensioni (LxPxH) Sizes (WxDxH) Dimension (LXPXH)	Dimensioni con imballo (LxPxH) Sizes with packing (WxDxH) Dimension (avec emballage) (LXPXH)	Peso netto/lordo Weight net/gross Poids net/brut
<b>CB 246</b>						V/Hz	W				
	24 Kg	6 kg circa 350	A W	A - 18g C - 33g D - 13g	R404A	220-240/1/50	350 W	A 5,1 W 14	mm 390x460x610	mm 440x510x725	35/41 Kg
<b>CB 249</b>		9 kg circa 530	A W	A - 18g C - 33g D - 13g	R404A	220-240/1/50	370 W	A 5,1 W 14	mm 390x460x690	mm 440x510x800	37/44Kg

Finitura: acciaio inox 18/8, scotch brite - Finishing: 18/8 stainless steel, scotch brite - Carrosserie: inox 18/8, scotch brite.



UNI EN ISO 9001  
Cert. N. 9130.BRE2



Condizioni  
Conditions  
Conditions



+21°C



+15°C



18 g

Watt + 43°C (230/1/50)



+10°C



+3°C

V / Hz

Minimum +10°C

Maximum +43°C

+3°C

+32°C

-10%

+10%



1bar (14psi)

6bar (84psi)



www.bremaice.it  
info@bremaice.it

**CB 316 / CB 416 / CB 425**



**CB Series**

Brema

CB316A



**CB 316/416**



**CB 425**

**Produttori automatici di ghiaccio in cubetti - sistema a spruzzo.**

Cubetti di qualità: compatti, freddi e cristallini. Il ghiaccio prodotto cade nel contenitore di raccolta pronto a soddisfare le esigenze di ghiaccio nelle ore di maggiore richiesta.

**Automatic ice cube maker - spray system.**

*Quality cubes: compact, cold and crystalline. The ice produced drops into the collection bin and is ready to meet the ice requirements even at peak demand times.*

**Machines à glaçons - système à projection d'eau.**

*Cubes de qualité: compacts et cristallins. Les glaçons produits tombent dans la réserve prêts à satisfaire les exigences aux heures de pointe.*



# CB Series

# CB 316-416 / CB 425

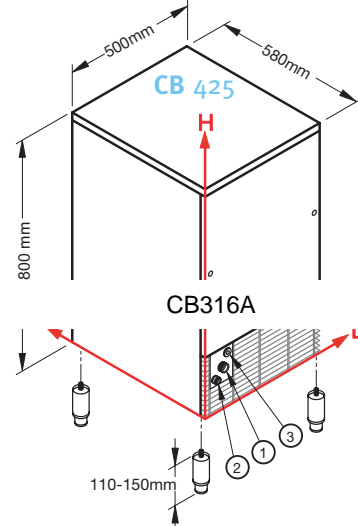
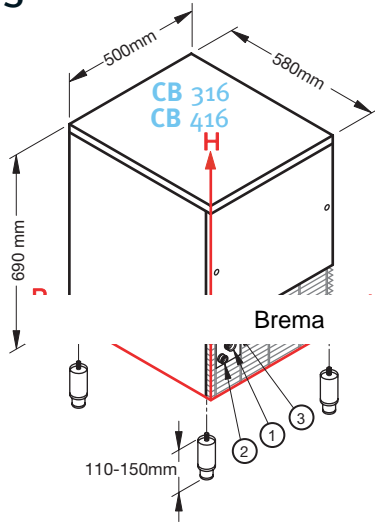

	1			2			3		
	L	H	Ø	L	H	Ø	L	H	Ø
<b>CB 316</b>	111	196	3/4"	49	151	24mm	156	232	-
<b>CB 416</b>	111	196	3/4"	49	151	24mm	156	232	-
<b>CB 425</b>	111	196	3/4"	49	151	24mm	156	232	-

	Produzione in 24 h, sino a: Production in 24 h till: Production en 24 h jusqu'à:	Capacità contenitore Storage capacity Reserve	Raffreddamento Cooling System Condenseur	Tipo di cubetto Kind of cube Type de glaçon	Refrigerante Refrigerant Fluide réfrigérant	Voltaggio Standard Standard Voltage Tension standard	Potenza assorbita Input power Puissance absorbée	Consumo acqua (l/kg) Water consumption (l/kg) Consommation d'eau (l/kg)	Dimensioni (LxPxH) Sizes (WxDxH) Dimension (LxPxH)	Dimensioni con imballo (LxPxH) Sizes with packing (WxDxH) Dimension (avec emballage) (LxPxH)	Peso netto/lordo Weight net/gross Poids net/brut
CB 316 CB 416 CB 425		 16 kg circa 950	 A W	 A - 18g C - 33g D - 13g	 R404A	V/Hz 220-240/1/50	W 370 W	 A W 3,3 13	 mm 500x580x690	 mm 550x630x805	 48/56 Kg
		 16 kg circa 950	 A W	 A - 18g C - 33g D - 13g	 R404A	V/Hz 220-240/1/50	W 450 W	 A W 4 15	 mm 500x580x690	 mm 550x630x805	 52/60 Kg
		 25kg circa 1470	 A W	 A - 18g C - 33g D - 13g	 R404A	V/Hz 220-240/1/50	W 500 W	 A W 4 14	 mm 500x580x800	 mm 550x630x915	 56/64 Kg

Finitura: acciaio inox 18/8, scotch brite - Finishing: 18/8 stainless steel, scotch brite - Carrosserie: inox 18/8, scotch brite.



Condizioni  
Conditions  
Conditions



V / Hz



UNI EN ISO 9001  
Cert. N. 9130.BRE2



+21°C +15°C  
Watt + 43°C (230/1/50)

Minimum	+10 °C	+3 °C	-10%	1bar (14psi)
Maximum	+43 °C	+32 °C	+10%	6bar (84psi)

OK

NO



www.bremaice.it  
info@bremaice.it

VIA DELL'INDUSTRIA, 10

20020 VILLA CORTESE (MI), ITALY

TEL. +39 0331 434811  
FAX +39 0331 433833

**CB 640 / CB 840 / CB 955**



**CB Series**

Brema

CB640A



**CB 640/840**



**CB 955**



**Produttori automatici di ghiaccio in cubetti - sistema a spruzzo.**

Cubetti di qualità: compatti, freddi e cristallini. Il ghiaccio prodotto cade nel contenitore di raccolta ghiaccio. Particolarmente adatti ai locali con forti necessità di ghiaccio in ristrette fasce orarie.

**Automatic ice cube maker - spray sistem.**

*Quality cubes: compact, cold and crystalline. The ice produced drops into the ice collection bin. Particularly suitable for activities with large-scale ice demands in limited time-spans.*

**Machines à glaçons - système à projection d'eau.**



*Cubes de qualité: compacts et cristallins. La glace produite tombe dans la réserve. Particulièrement adaptés aux locaux nécessitant de grandes quantités de glace dans des phases horaires limitées.*





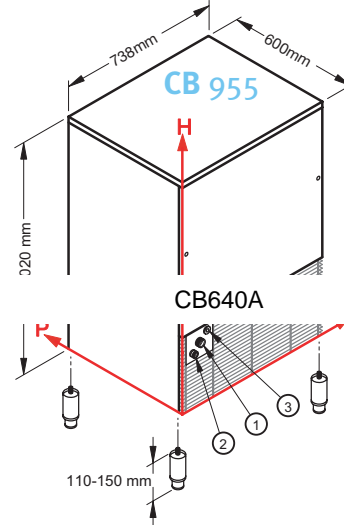
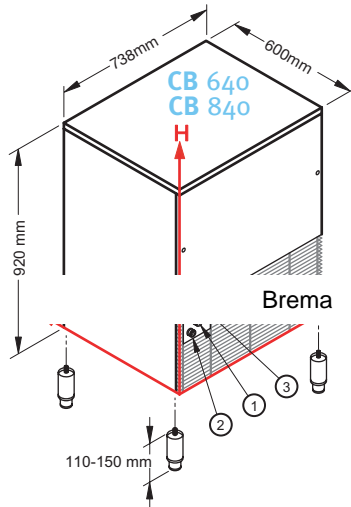





# CB Series

# CB 640-840 / CB 955

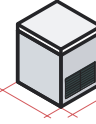

	1 			2 			3 		
	L	H	Ø	L	H	Ø	L	H	Ø
<b>CB 640</b>	116	285	3/4"	54	240	24mm	161	321	-
<b>CB 840</b>	116	285	3/4"	54	240	24mm	161	321	-
<b>CB 955</b>	116	285	3/4"	54	240	24mm	161	321	-

	Produzione in 24 h, sino a: Production in 24 h till: Production en 24 h jusqu'à:	Capacità contenitore Storage capacity Reserve	Raffreddamento Cooling System Condenseur	Tipo di cubetto Kind of cube Type de glaçon	Refrigerante Refrigerant Fluide réfrigérant	Vtaggio Standard Standard Voltage Tension standard	Potenza assorbita Input power Puissance absorbée	Consumo acqua (l/kg) Water consumption (l/kg) Consommation d'eau (l/kg)	Dimensioni (LxPxH) Sizes (MxDxH) Dimension (LXPXH)	Dimensioni con imballo (LxPxH) Sizes with packing (MxDxH) Dimension (avec emballage) (LXPXH)	Peso netto/lordo Weight net/gross Poids net/brut
						V/Hz	W				
CB 316	65 Kg	40 kg circa 2350	A W	A - 18g C - 33g D - 13g	R404A	220-240/1/50	650 W	A 2,8 W 12,8	738x600x920	780x640x1030	77/89Kg
CB 416	80 Kg	40 kg circa 2350	A W	A - 18g C - 33g D - 13g	R404A	220-240/1/50	800 W	A 2,6 W 14,4	738x600x920	780x640x1030	86/98 Kg
CB 425	90 Kg	55 kg circa 3240	A W	A - 18g C - 33g D - 13g	R404A	220-240/1/50	850 W	A 2,5 W 14,2	738x600x1020	780x640x1130	89/102 Kg

Finitura: acciaio inox 18/8, scotch brite - Finishing: 18/8 stainless steel, scotch brite - Carrosserie: inox 18/8, scotch brite.



UNI EN ISO 9001  
Cert. N. 9130.BRE2



Condizioni  
Conditions  
Conditions



+21°C



+15°C



18 g

Watt + 43°C (230/1/50)



Minimum +10 °C



Maximum +43 °C



Minimum +3 °C

Maximum +32 °C

V / Hz

Minimum -10%

Maximum +10%



Minimum 1bar (14psi)

Maximum 6bar (84psi)



OK



NO



www.bremaice.it  
info@bremaice.it



CB 640 / CB 840 / CB 955



CB Series

Brema

CB955A



CB 640/840



CB 955



**Produttori automatici di ghiaccio in cubetti - sistema a spruzzo.**

Cubetti di qualità: compatti, freddi e cristallini. Il ghiaccio prodotto cade nel contenitore di raccolta ghiaccio. Particolarmente adatti ai locali con forti necessità di ghiaccio in ristrette fasce orarie.

**Automatic ice cube maker - spray sistem.**

*Quality cubes: compact, cold and crystalline. The ice produced drops into the ice collection bin. Particularly suitable for activities with large-scale ice demands in limited time-spans.*

**Machines à glaçons - système à projection d'eau.**



*Cubes de qualité: compacts et cristallins. La glace produite tombe dans la réserve. Particulièrement adaptés aux locaux nécessitant de grandes quantités de glace dans des phases horaires limitées.*





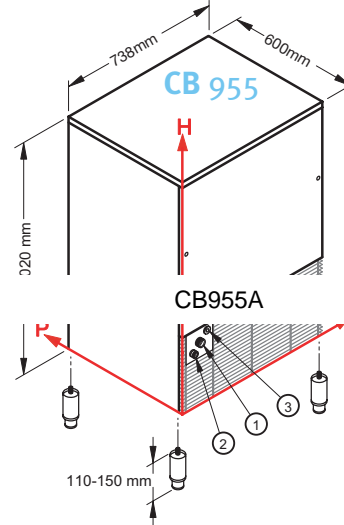
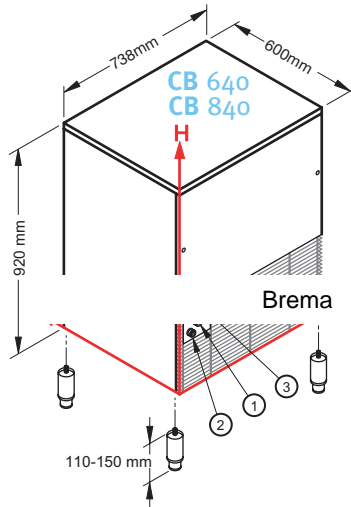



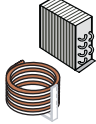

# CB Series

# CB 640-840 / CB 955

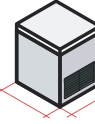

	1 			2 			3 		
	L	H	Ø	L	H	Ø	L	H	Ø
<b>CB 640</b>	116	285	3/4"	54	240	24mm	161	321	-
<b>CB 840</b>	116	285	3/4"	54	240	24mm	161	321	-
<b>CB 955</b>	116	285	3/4"	54	240	24mm	161	321	-

	Produzione in 24 h, sino a: Production in 24 h till: Production en 24 h jusqu'à:	Capacità contenitore Storage capacity Reserve	Raffreddamento Cooling System Condenseur	Tipo di cubetto Kind of cube Type de glaçon	Refrigerante Refrigerant Fluide réfrigérant	Vtaggio Standard Standard Voltage Tension standard	Potenza assorbita Input power Puissance absorbée	Consumo acqua (l/kg) Water consumption (l/kg) Consommation d'eau (l/kg)	Dimensioni (LxPxH) Sizes (MxDxH) Dimension (LXPxH)	Dimensioni con imballo (LxPxH) Sizes with packing (MxDxH) Dimension (avec emballage) (LXPxH)	Peso netto/lordo Weight net/gross Poids net/brut
						V/Hz	W				
<b>CB 316</b>	65 Kg	40 kg circa 2350	A W	A - 18g C - 33g D - 13g	R404A	220-240/1/50	650 W	A 2,8 W 12,8	738x600x920	780x640x1030	77/89Kg
<b>CB 416</b>	80 Kg	40 kg circa 2350	A W	A - 18g C - 33g D - 13g	R404A	220-240/1/50	800 W	A 2,6 W 14,4	738x600x920	780x640x1030	86/98 Kg
<b>CB 425</b>	90 Kg	55 kg circa 3240	A W	A - 18g C - 33g D - 13g	R404A	220-240/1/50	850 W	A 2,5 W 14,2	738x600x1020	780x640x1130	89/102 Kg

Finitura: acciaio inox 18/8, scotch brite - Finishing: 18/8 stainless steel, scotch brite - Carrosserie: inox 18/8, scotch brite.



Condizioni  
Conditions  
Conditions

UNI EN ISO 9001  
Cert. N. 9130.BRE2



Watt + 43°C (230/1/50)



V / Hz



Minimum	+10 °C	+3 °C	-10%	1bar (14psi)
Maximum	+43 °C	+32 °C	+10%	6bar (84psi)



www.bremaice.it  
info@bremaice.it

VIA DELL'INDUSTRIA, 10

20020 VILLA CORTESE (MI), ITALY

TEL. +39 0331 434811  
FAX +39 0331 433833

CB 1265 / CB 1565



**CB Series**

Brema

CB1265A



CB 1265



CB 1565



**Produttori automatici di ghiaccio in cubetti - sistema a spruzzo.**

Cubetti di qualità: compatti, freddi e cristallini. Il ghiaccio prodotto cade nel contenitore di raccolta ghiaccio. Particolarmente adatti ai locali con forti necessità di ghiaccio in ristrette fasce orarie.

**Automatic ice cube maker - spray sistem.**

*Quality cubes: compact, cold and crystalline. The ice produced drops into the ice collection bin. Particularly suitable for activities with large-scale ice demands in limited time-spans.*

**Machines à glaçons - système à projection d'eau.**

*Cubes de qualité: compacts et cristallins. La glace produite tombe dans la réserve. Particulièrement adaptés aux locaux nécessitant de grandes quantités de glace dans des phases horaires limitées.*



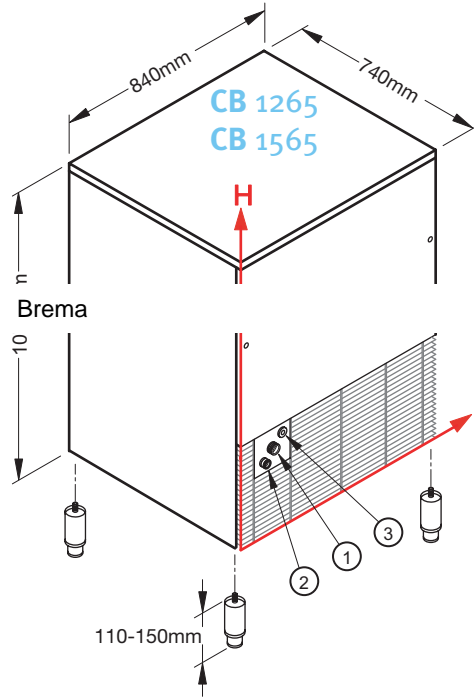

	1			2			3		
	L	H	Ø	L	H	Ø	L	H	Ø
<b>CB 1265</b>	141	290	3/4"	79	245	24mm	186	326	-
<b>CB 1565</b>	141	290	3/4"	79	245	24mm	186	326	-

	Produzione in 24 h, sino a: Production in 24 h till: Production en 24 h jusqu'à:	Capacità contenitore Storage capacity Reserve	Raffreddamento Cooling System Condenseur	Tipo di cubetto Kind of cube Type de glaçon	Refrigerante Refrigerant Fluide réfrigérant	Voltaggio Standard Standard Voltage Tension standard	Potenza assorbita Input power Puissance absorbée	Consumo acqua (l/kg) Water consumption (l/kg) Consommation d'eau (l/kg)	Dimensioni (LxPxH) Sizes (WxDxH) Dimension (LXPXH)	Dimensioni con imballo (LxPxH) Sizes with packing (WxDxH) Dimension (avec emballage) (LXPXH)	Peso netto/lordo Weight net/gross Poids net/brut
<b>CB 1565 CB 1265</b>						V/Hz	W				
	130 Kg	65 kg circa 3830	A W	A - 18g C - 33g D - 13g	R404A	220-240/1/50	1050 W	A 2,8 W 15,3	mm 840x740x1075	mm 880x785x1245	113/133 Kg
	155 Kg	65 kg circa 3830	A W	A - 18g C - 33g D - 13g	R404A	220-240/1/50	1400 W	A 2,6 W 13	mm 840x740x1075	mm 880x785x1245	118/138 Kg

Finitura: acciaio inox 18/8, scotch brite - Finishing: 18/8 stainless steel, scotch brite - Carrosserie: inox 18/8, scotch brite.



UNI EN ISO 9001  
Cert. N. 9130,BRE2



DHSAS 18001: 1999  
Cert. N. 9192,BRE3



+21°C



+15°C



18 g

Watt + 43°C (230/1/50)



+10 °C



+3 °C

V / Hz

-10%



1bar (14psi)

Minimum

Maximum

+43 °C

+32 °C

+10%

6bar (84psi)



OK



NO



www.bremaice.it  
info@bremaice.it